

Area of a Quadrilateral

Find the area of each quadrilateral.

1)

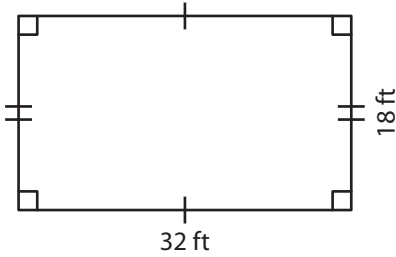

Area = _____

2)

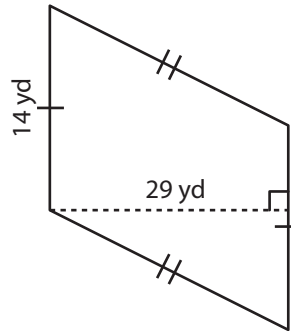

Area = _____

3)

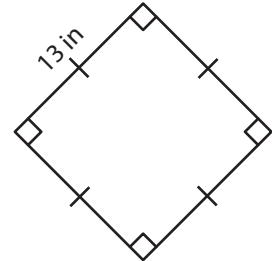

Area = _____

4)

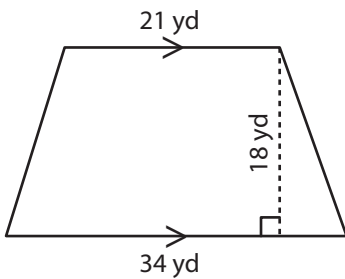

Area = _____

5)

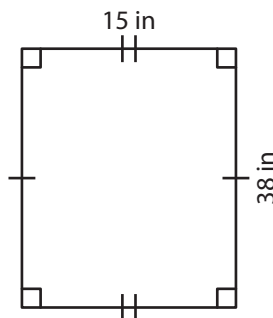

Area = _____

6)

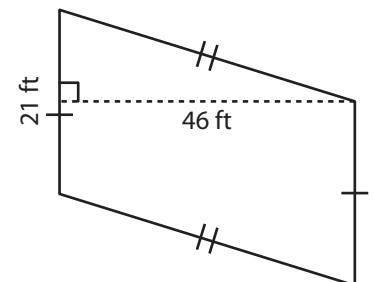

Area = _____

7)

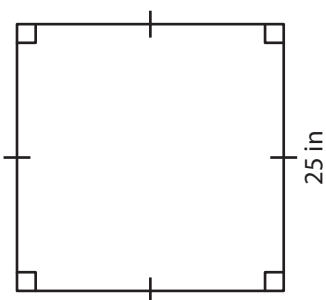

Area = _____

8)

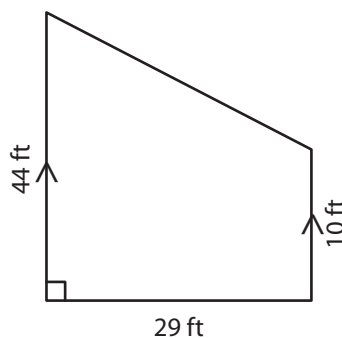

Area = _____

9)

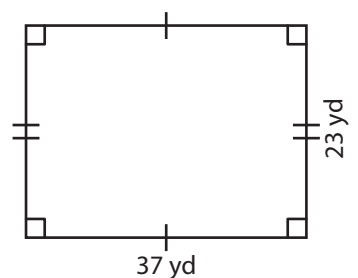

Area = _____

Area of a Quadrilateral

Answer Key

Find the area of each quadrilateral.

1)

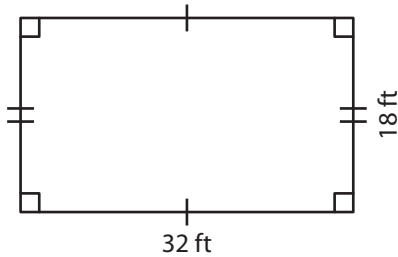

Area = 576 ft²

2)

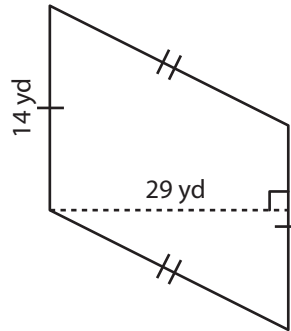

Area = 406 yd²

3)

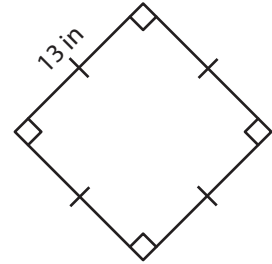

Area = 169 in²

4)

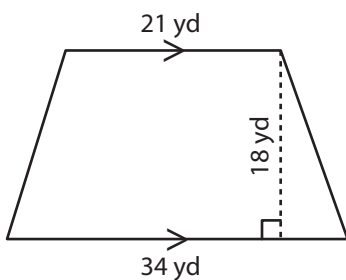

Area = 495 yd²

5)

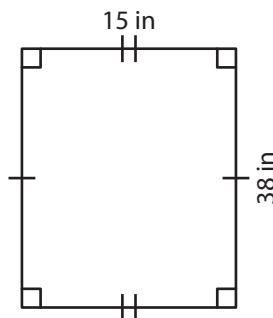

Area = 570 in²

6)

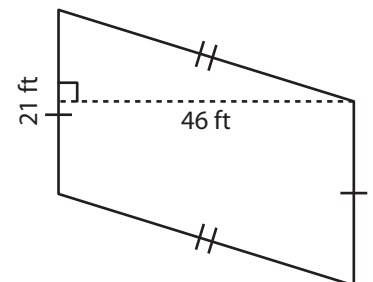

Area = 966 ft²

7)

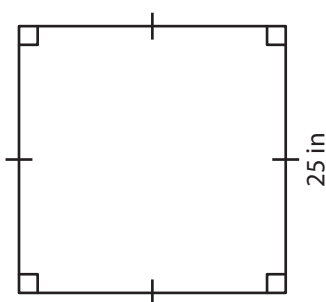

Area = 625 in²

8)

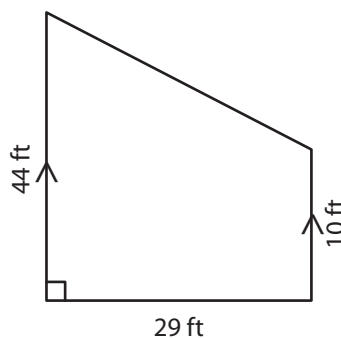

Area = 783 ft²

9)

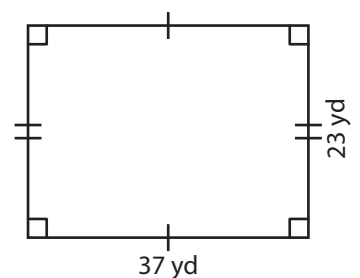

Area = 851 yd²