

# Area of a Trapezoid

Find the area of each trapezoid. Round your answer to two decimal places.

1)

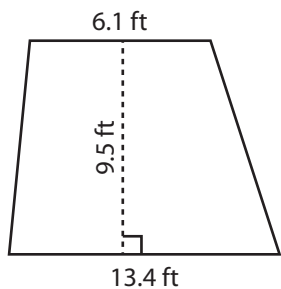

Area = \_\_\_\_\_

2)

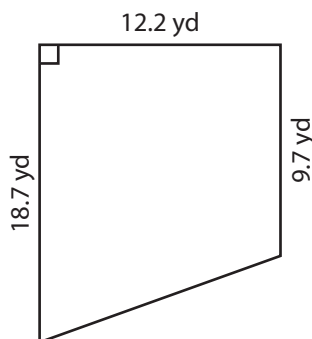

Area = \_\_\_\_\_

3)

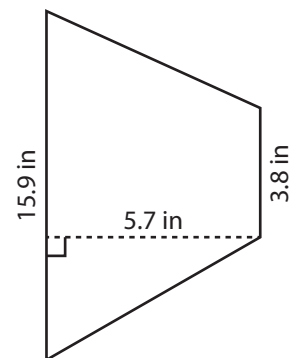

Area = \_\_\_\_\_

4)

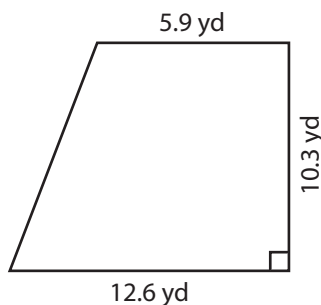

Area = \_\_\_\_\_

5)

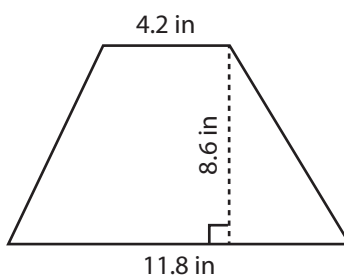

Area = \_\_\_\_\_

6)

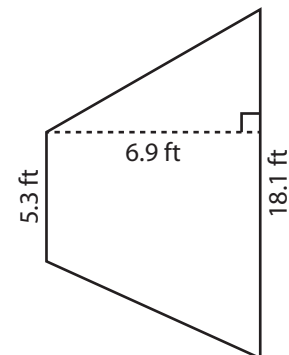

Area = \_\_\_\_\_

7)

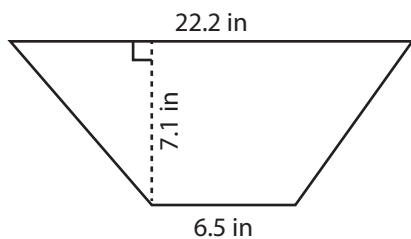

Area = \_\_\_\_\_

8)

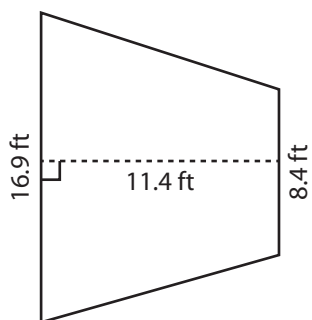

Area = \_\_\_\_\_

9)

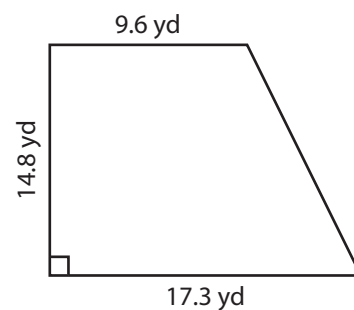

Area = \_\_\_\_\_