

Perimeter of a Kite

Find the perimeter of each kite.

1)

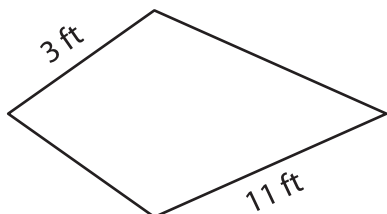

Perimeter = _____

2)

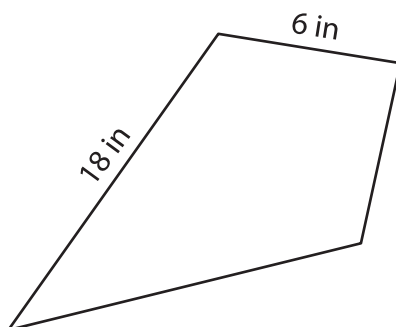

Perimeter = _____

3)

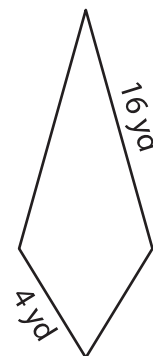

Perimeter = _____

4)

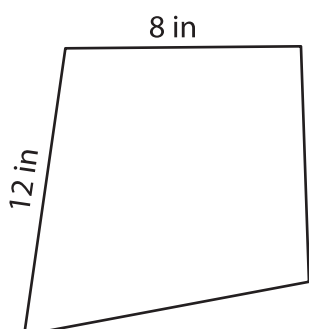

Perimeter = _____

5)

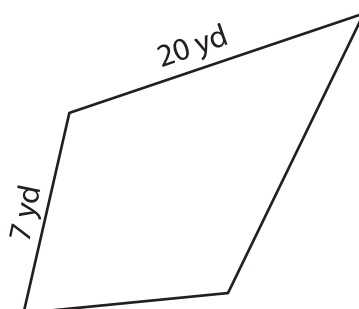

Perimeter = _____

6)

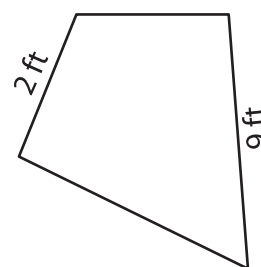

Perimeter = _____

7)

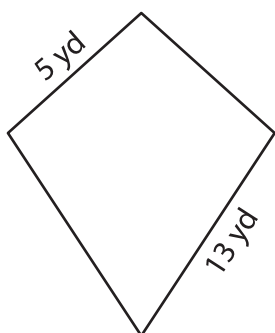

Perimeter = _____

8)

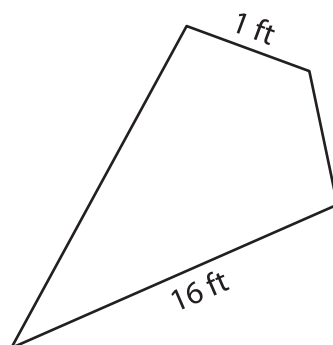

Perimeter = _____

9)

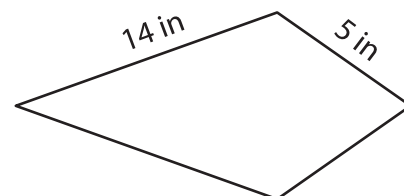

Perimeter = _____