

Surface Area of a Square Pyramid

Find the surface area of each square pyramid.

1)

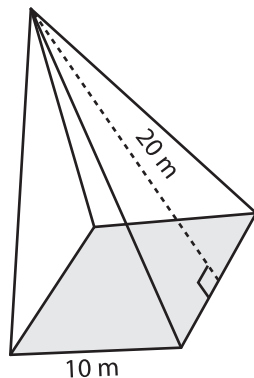

Surface Area = _____

2)

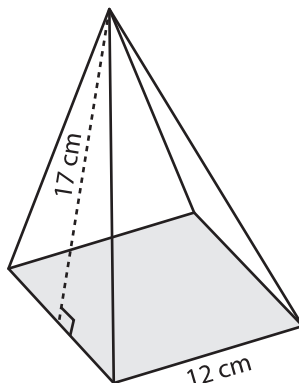

Surface Area = _____

3)

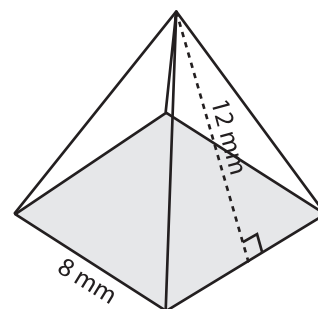

Surface Area = _____

4)

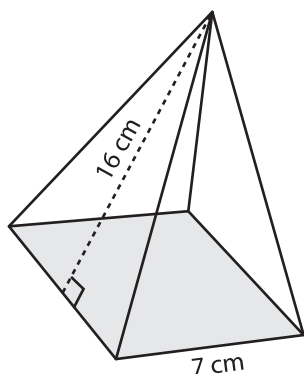

Surface Area = _____

5)

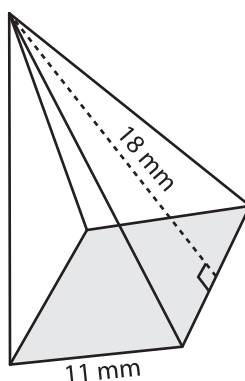

Surface Area = _____

6)

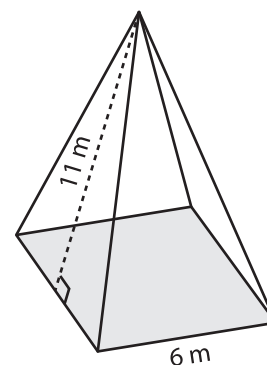

Surface Area = _____

7)

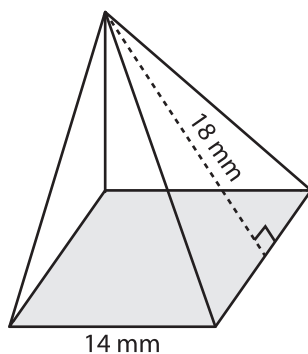

Surface Area = _____

8)

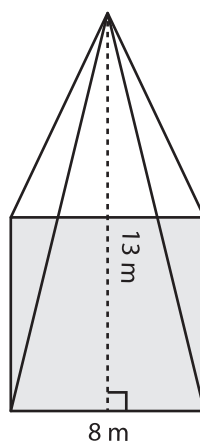

Surface Area = _____

9)

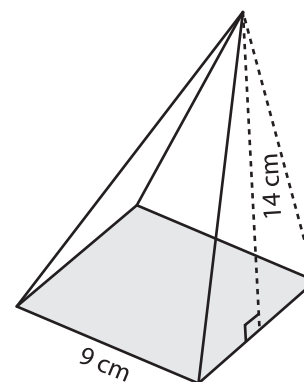

Surface Area = _____