

Volume of a Rectangular Prism

Find the volume of each rectangular prism.

1)

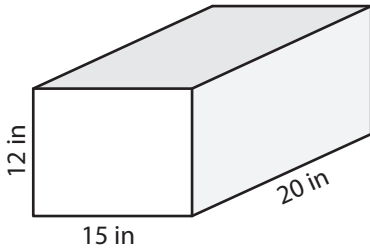

2)

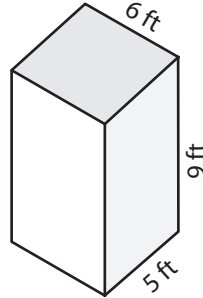

3)

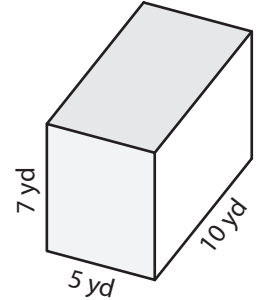

4)

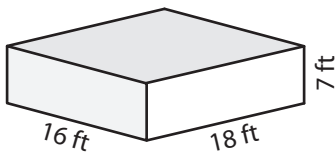

5)

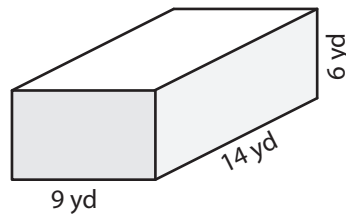

6)

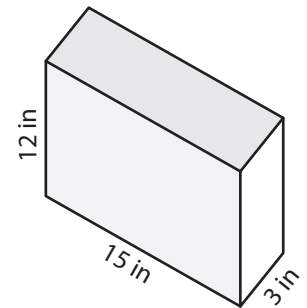

7)

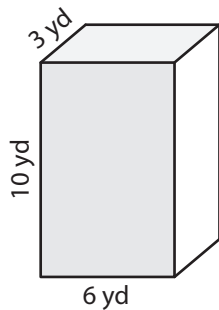

8)

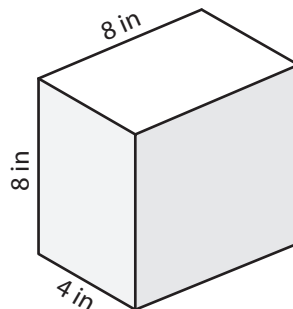

9)

